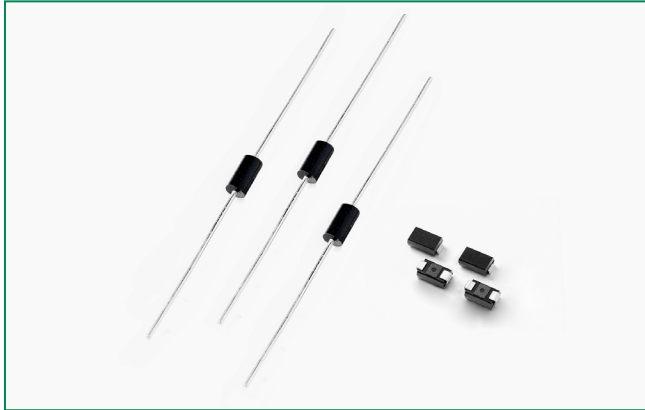


## Kxxx0yU SIDAC Series

RoHS



### Description

The SIDAC is a silicon unilateral voltage triggered switch. Upon application of a voltage exceeding the SIDAC breakover voltage point, the SIDAC switches on through a negative resistance region to a low on-state voltage. Conduction continues until the current is interrupted or drops below the minimum holding current of the device.

SIDACs feature glass-passivated junctions to ensure a rugged and dependable device capable of withstanding harsh environments.

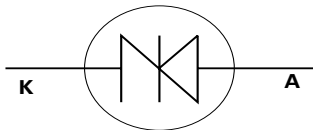
### Features

- Rectified AC/DC Circuit Oriented
- RoHS Compliant
- Triggering Voltage of 75V to 260V

### Applications

Suitable for capacitor-discharge HV generator circuit

### Schematic Symbol



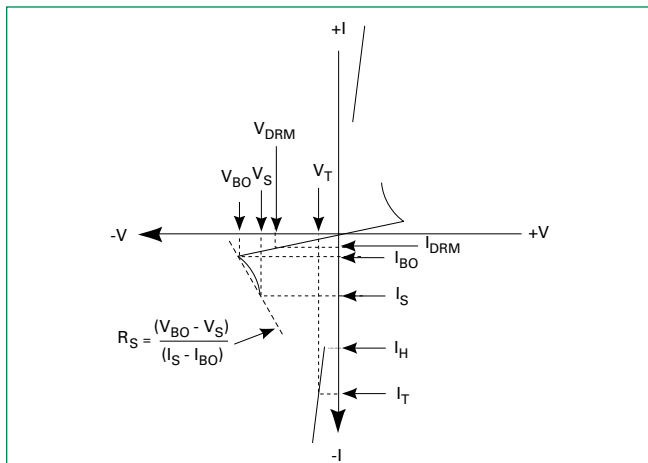
### Electrical Specifications ( $T_J = 25^\circ\text{C}$ , unless otherwise specified)

Symbol	Parameters	Test Conditions	min	max	Unit
$V_{BO}$	Breakover/Trigger Voltage	K0820yURP	75	90	V
		K0900yURP	79	97	
		K1050yURP	95	110	
		K1100yURP	104	118	
		K1200yURP	110	125	
		K1300yURP	120	138	
		K1400yURP	130	146	
		K1500yURP	142	157	
		K1800yURP	167	183	
		K2000yURP	190	210	
		K2200yURP	210	230	
		K2300yURP	220	240	
		K2400yURP	230	250	
		K2500yURP	240	260	
$V_{DRM}$	Repetitive Peak Off-state Voltage	K0820yURP	70		V
		K0900yURP	70		
		K1050yURP	90		
		K1100yURP	90		
		K1200yURP	100		
		K1300yURP	110		
		K1400yURP	115		
		K1500yURP	120		
		K1800yURP	150		
		K2000yURP	170		
		K2200yURP	190		
		K2300yURP	200		
		K2400yURP	210		
		K2500yURP	220		

**Electrical Specifications ( $T_J = 25^\circ\text{C}$ , unless otherwise specified)**

Symbol	Parameters	Test Conditions	Min	Max	Unit	
$I_{T(RMS)}$	On-state RMS Current	50/60Hz		1	A	
$I_{DRM}$	Repetitive Peak Off-state Current	$V = V_{DRM}$ 50/60Hz Sine Wave		5	$\mu\text{A}$	
$V_{TM}$	Peak On-state Voltage	$I_T = 1\text{A}$		1.2	V	
$I_H$	Dynamic Holding Current	$R_T = 100\Omega$ 50/60Hz Sine Wave	10	80	mA	
$R_S$	Switching Resistance, $R_S = \frac{(V_{BO} - V_S)}{(I_S - I_{BO})}$	50/60Hz Sine Wave	100		$\Omega$	
$I_{BO}$	Breakover Current	50/60Hz Sine Wave		10	$\mu\text{A}$	
$I_{TRM}$	Peak Repetitive Pulse Current (refer to figure 4)	K0820yU~ K0900yU	$T_P = 10\mu\text{s}$ $T_A = 125^\circ\text{C}$	60Hz 5Hz	80 160	A
		K1050yU~ K2000yU	$T_P = 10\mu\text{s}$ $T_A = 125^\circ\text{C}$	60Hz 5Hz	120 280	
		K2200yU~ K2500yU	$T_P = 10\mu\text{s}$ $T_A = 135^\circ\text{C}$	60Hz 5Hz	120 280	
$I_{TSM}$	Peak Non-repetitive Surge Current (refer to figure 5)	Single Cycle	60Hz 50Hz	20 16.7	A	
di/dt	Critical Rate of Rise of On-state Current			150	A/ $\mu\text{s}$	
dv/dt	Critical Rate of Rise of Off-state Voltage		1500		V/ $\mu\text{s}$	
$T_S$	Storage Temperature Range		-40	150	$^\circ\text{C}$	
$T_J$	Junction Temperature Range	K0820yU~K2000yU	-40	125	$^\circ\text{C}$	
		K2200yU~K2500yU	-40	150		
$R_{\theta JL}$	Thermal Resistance, Junction to Lead	DO-214		30	$^\circ\text{C/W}$	
		DO-15		18		

**Figure 1: V-I Characteristics**



**Figure 2: On-state Current vs. On-state Voltage (Typical)**

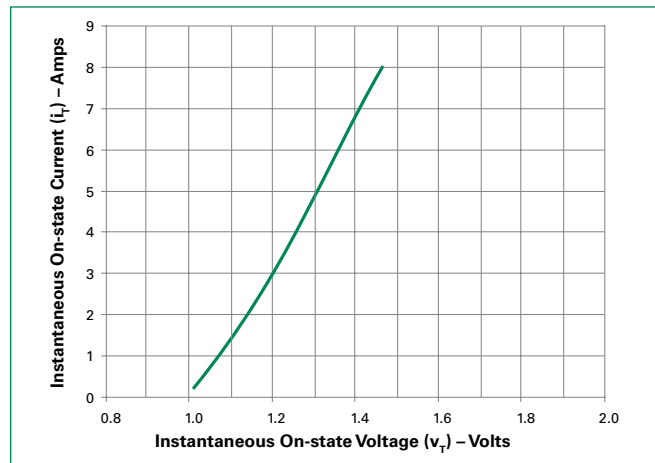


Figure 3: Power Dissipation vs. On-state Current (Typical)

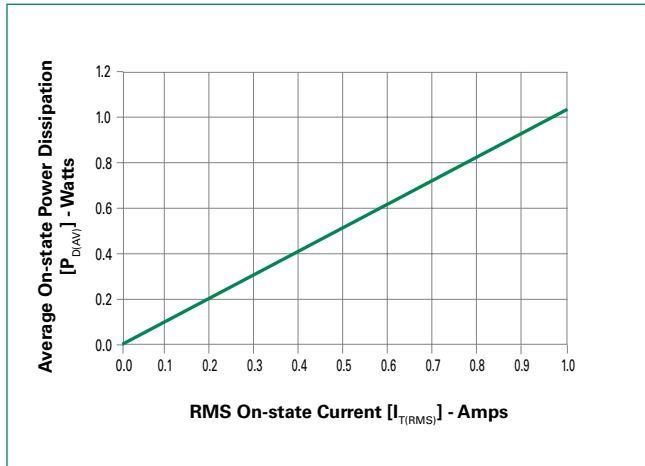


Figure 4: Peak Non-repetitive Surge Current ( $I_{TSM}$ ) vs. Number of Cycles

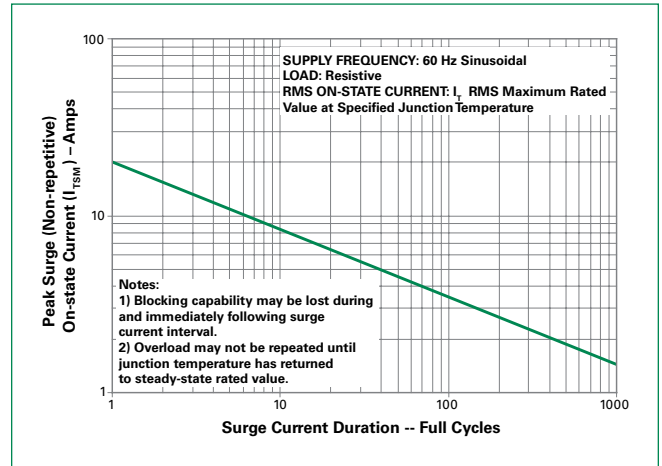


Figure 5: Repetitive Peak On-state Current ( $I_{TRM}$ ) vs. Pulse Width at Various Frequencies of K0820yU/K0900yU

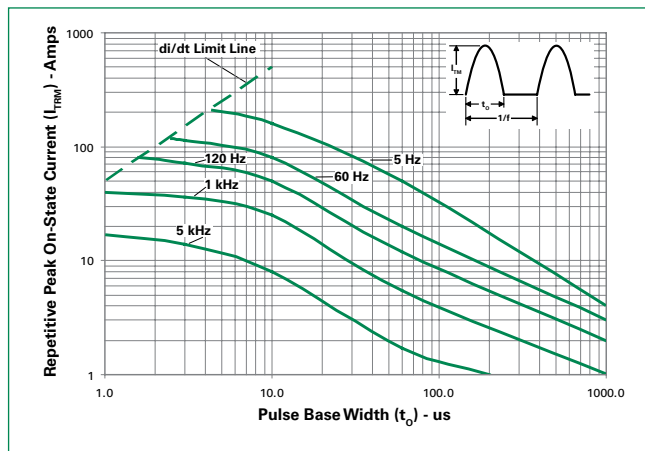


Figure 6: Repetitive Peak On-state Current ( $I_{TRM}$ ) vs. Pulse Width at Various Frequencies of K1050yU~K2500yU

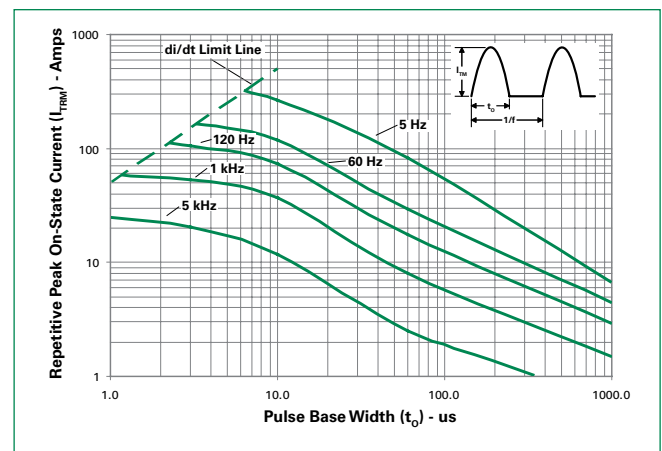


Figure 7: Normalized  $V_{BO}$  Change vs. Junction Temperature

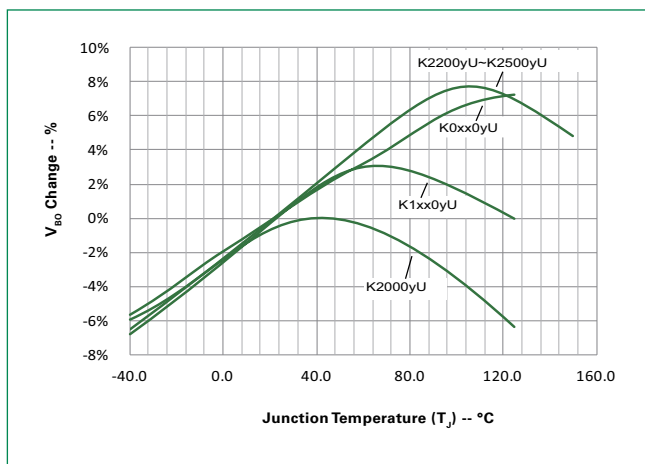
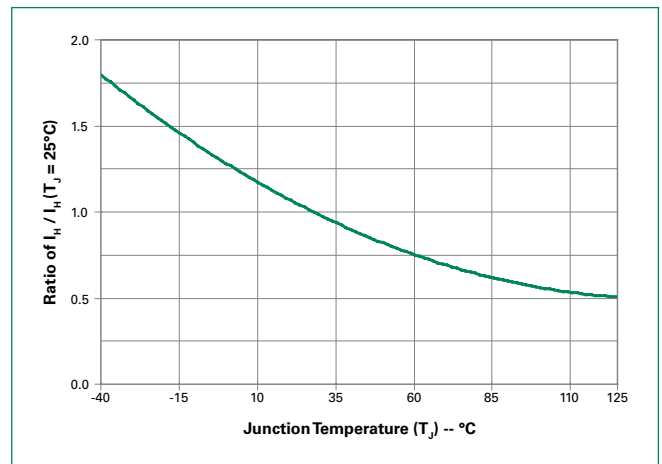
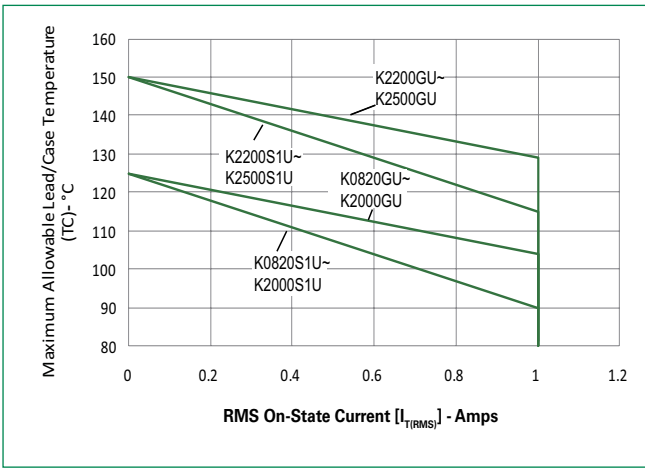


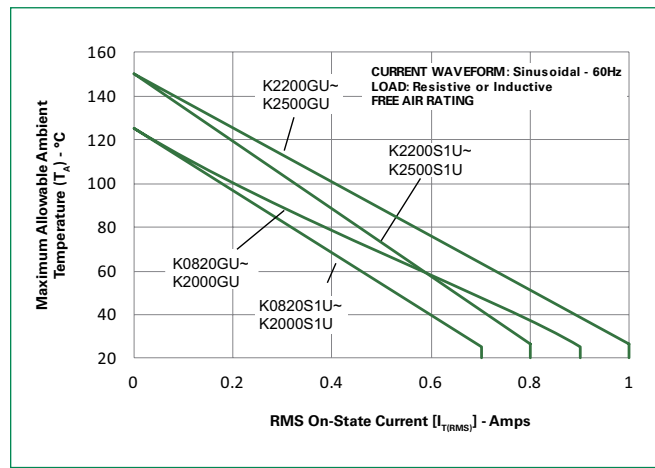
Figure 8: Normalized DC Holding Current vs. Junction Temperature



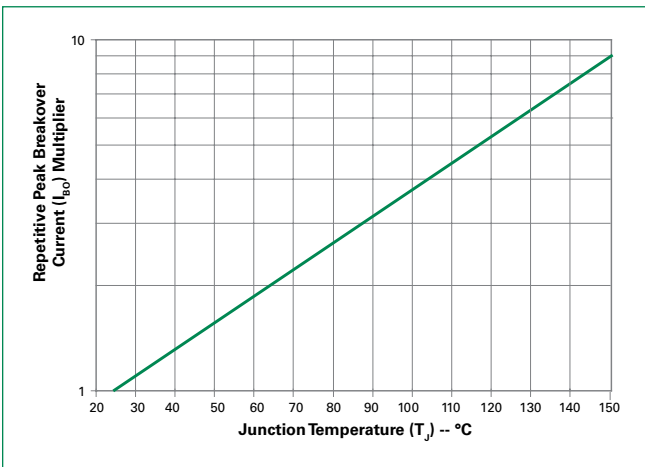
**Figure 9: Maximum Allowable Case Temperature vs. RMS On-State Current**



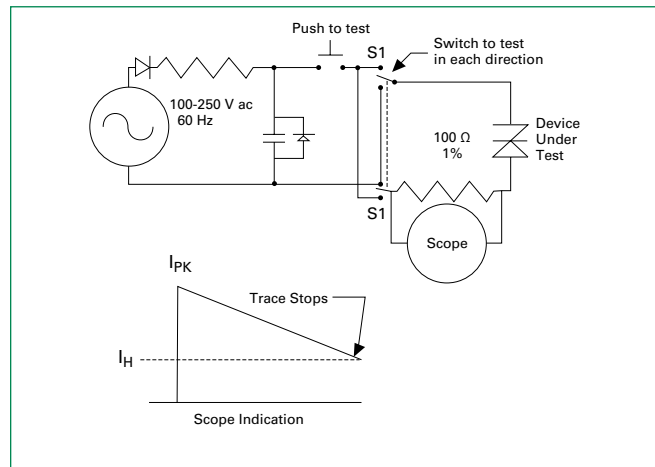
**Figure 10: Maximum Allowable Ambient Temperature vs. RMS On-State Current**



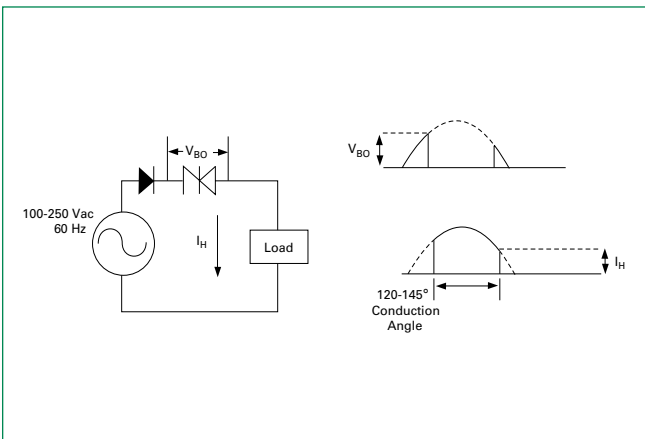
**Figure 11: Normalized Repetitive Peak Breakover Current (I\_BO) vs. Junction Temperature**



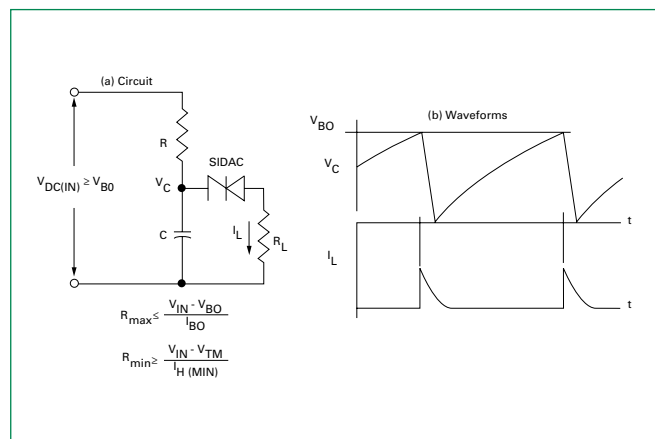
**Figure 12: Dynamic Holding Current Test Circuit for SIDACs**



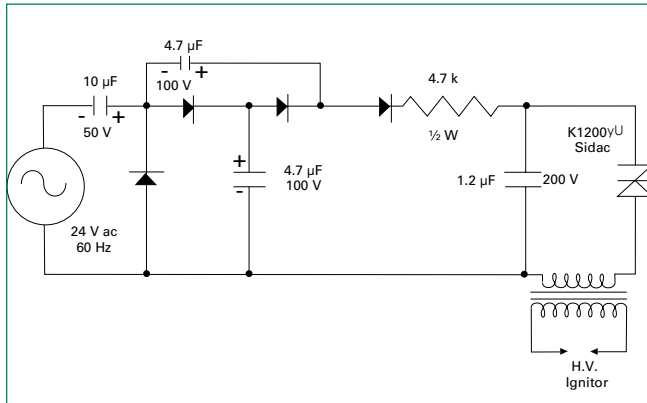
**Figure 13: Basic SIDAC Circuit**



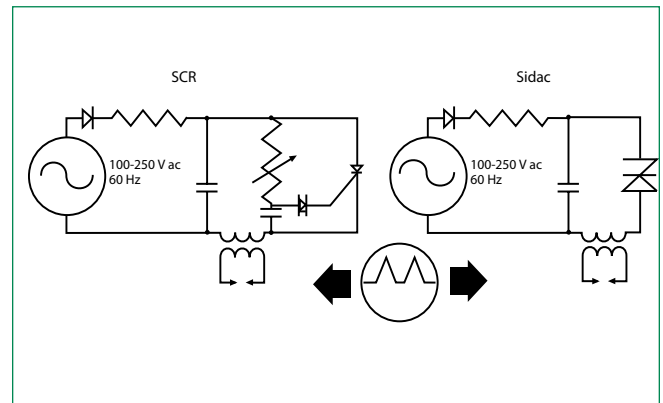
**Figure 14: Relaxation Oscillator Using a SIDAC**



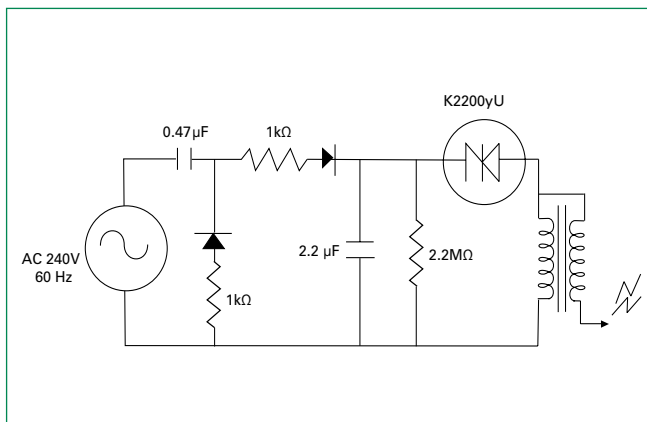
**Figure 15: Low-voltage Input Circuit for Gas Ignition**



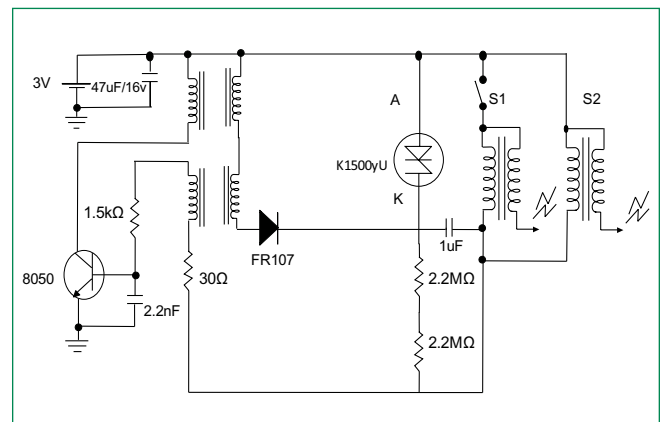
**Figure 16: Comparison of SIDAC versus SCR for Gas Ignitor Circuit**



**Figure 17: SIDAC Circuit for High-power Igniter**

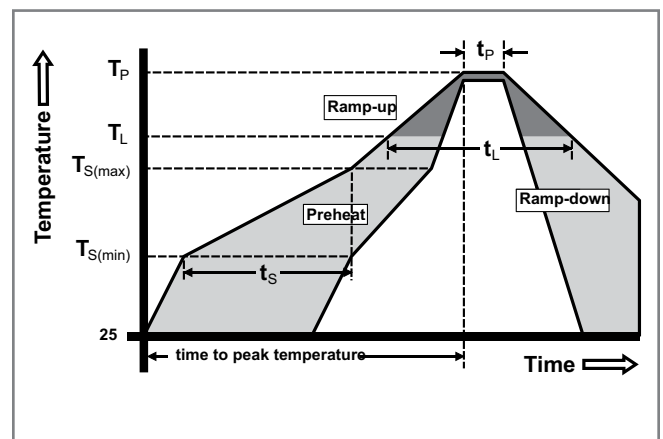


**Figure 18: SIDAC Circuit for Gas Ignition**



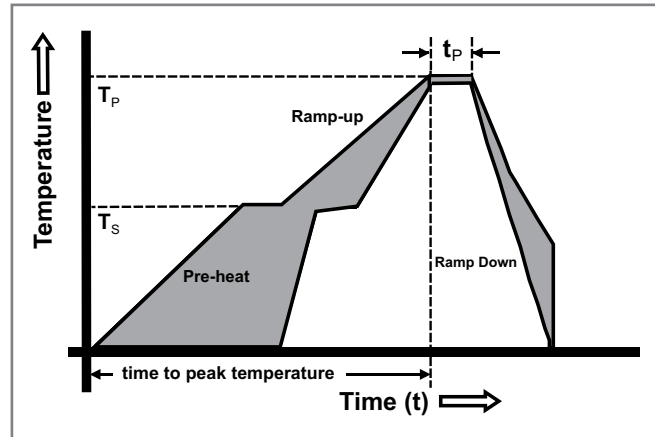
**Soldering Parameters**

Reflow condition		Pb - Free assembly
Pre Heat	-Temperature Min ( $T_{s(min)}$ )	150°C
	-Temperature Max ( $T_{s(max)}$ )	200°C
	-Time (min to max) ( $t_s$ )	60-180 secs
Average ramp up rate (Liquidus Temp ( $T_L$ ) to peak)		5°C/second max
$T_{s(max)}$ to $T_L$ - Ramp-up Rate		5°C/second max
Reflow	-Temperature ( $T_L$ ) (Liquidus)	217°C
	-Time ( $t_L$ )	60-150 seconds
Peak Temperature ( $T_p$ )		260+0/-5 °C
Time within 5°C of actual peak Temperature( $t_p$ )		20-40 seconds
Ramp-down Rate		5°C/second max
Time 25°C to peak Temperature( $T_p$ )		8 minutes max
Do not exceed		280°C



**Flow Soldering (Solder Dipping)**

Wave soldering condition		Pb - Free assembly
Pre Heat	- Temperature Min	140°C
	- Temperature Max	160°C
	Time to Pre-Heat Temp	60-150 seconds
Average ramp up rate to Pre-Heat Temp		5°C/second max
Peak Temperature		260+0/-5 °C
Average ramp up rate (T <sub>pre-heat</sub> to T <sub>p</sub> )		5°C/second max
Time within actual peak Temperature Max		6 seconds
Ramp-down Rate		5°C/second max



**Physical Specifications**

<b>Terminal Finish</b>	100% Matte Tin Plated
<b>Body Material</b>	UL recognized epoxy meeting flammability classification 94V-0
<b>Lead Material</b>	Copper Alloy

**Design Considerations**

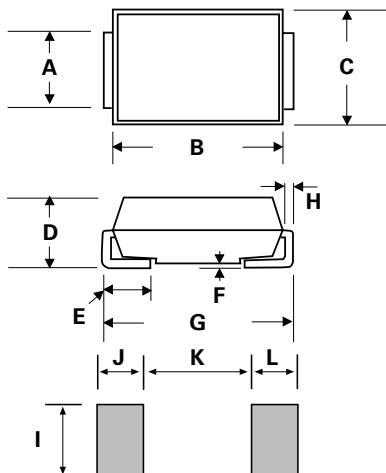
Careful selection of the correct device for the application's operating parameters and environment will go a long way toward extending the operating life of the Thyristor. Overheating and surge currents are the main killers of SIDACs. Correct mounting, soldering, and forming of the leads also help protect against component damage.

**Reliability/Environmental Tests**

Test	Specifications and Conditions
<b>High Temperature Voltage Blocking</b>	MIL-STD-750: Method 1040, Condition A Rated $V_{DRM}$ (Rectified VAC-peak), $T_j$ , 504 hours
<b>Temperature Cycling</b>	MIL-STD-750: Method 1051 -40°C to 150°C, 15-minute dwell, 100 cycles
<b>Biased Temperature &amp; Humidity</b>	EIA/JEDEC: JESD22-A101 80% min $V_{BO}$ ( $V_{DC}$ ), 85°C, 85%RH, 1008 hours
<b>High Temp Storage</b>	MIL-STD-750: Method 1031 150°C, 1008 hours
<b>Low-Temp Storage</b>	-40°C, 1008 hours
<b>Thermal Shock</b>	MIL-STD-750: Method 1056 0°C to 100°C, 5-minute dwell, 10-second transfer, 10 cycles
<b>Resistance to Solder Heat</b>	MIL-STD-750: Method 2031 260°C, 10 seconds
<b>Solderability</b>	ANSI/J-STD-002: Category 3
<b>Lead Bend</b>	MIL-STD-750: Method 2036, Condition E

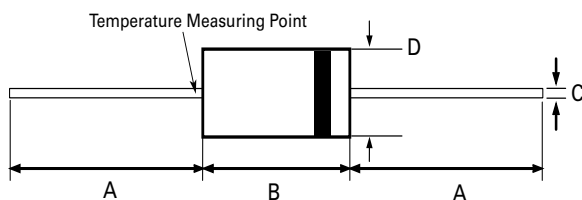
**Dimensions**

**DO-214AC (SMA)**



Dimensions	Inches		Millimeters	
	Min	Max	Min	Max
A	0.049	0.065	1.250	1.650
B	0.157	0.177	3.990	4.500
C	0.100	0.110	2.540	2.790
D	0.078	0.090	1.980	2.290
E	0.030	0.060	0.780	1.520
F	-	0.008	-	0.203
G	0.194	0.208	4.930	5.280
H	0.006	0.012	0.152	0.305
I	0.070	-	1.800	-
J	0.082	-	2.100	-
K	-	0.090	-	2.300
L	0.082	-	2.100	-

**Dimensions — DO-15**



Dimension	Inches		Millimeters	
	Max	Max	Min	Max
A	1.000	-	25.40	-
B	0.230	0.300	5.80	7.60
C	0.028	0.034	0.71	0.86
D	0.104	0.140	2.60	3.60

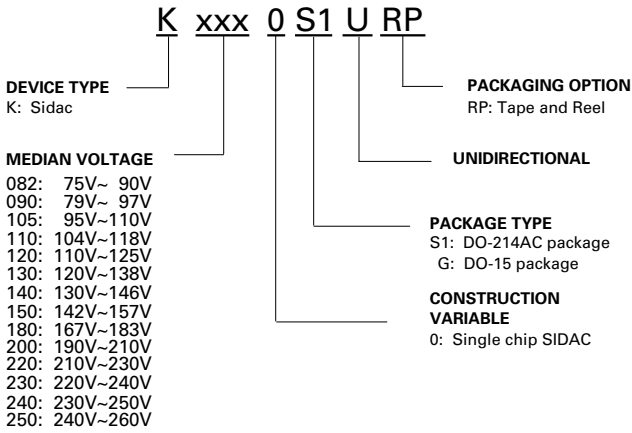
**Product Selector**

Part Number	Switching Voltage Range		Blocking Voltage $V_{DRM}$	Packages	
	$V_{BO}$ Minimum	$V_{BO}$ Maximum		DO-15	DO-214
K0820yURP	75	90	70	K0820GURP	K0820S1URP
K0900yURP	79	97	70	K0900GURP	K0900S1URP
K1050yURP	95	110	90	K1050GURP	K1050S1URP
K1100yURP	104	118	90	K1100GURP	K1100S1URP
K1200yURP	110	125	100	K1200GURP	K1200S1URP
K1300yURP	120	138	110	K1300GURP	K1300S1URP
K1400yURP	130	146	115	K1400GURP	K1400S1URP
K1500yURP	142	157	120	K1500GURP	K1500S1URP
K1800yURP	167	183	150	K1800GURP	K1800S1URP
K2000yURP	190	210	170	K2000GURP	K2000S1URP
K2200yURP	210	230	190	K2200GURP	K2200S1URP
K2300yURP	220	240	200	K2300GURP	K2300S1URP
K2400yURP	230	250	210	K2400GURP	K2400S1URP
K2500yURP	240	260	220	K2500GURP	K2500S1URP

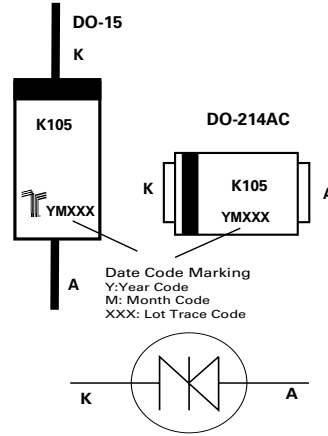
**Packing Options**

Part Number	Marking	Weight	Package Mode	Packages	Base Quantity
Kxxx0S1URP	Kxxx	0.062g	Reel Pack	DO-214AC	5000
Kxxx0GURP	Kxxx	0.38g	Reel Pack	DO-15	5000

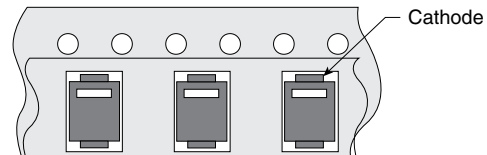
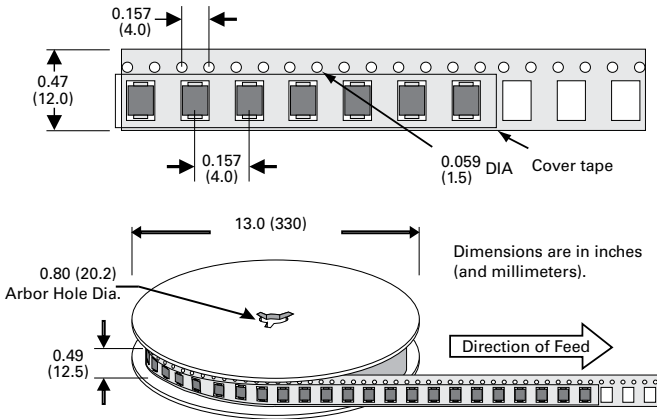
**Part Numbering System**



**Part Marking System**



**Tape and Reel Specification – DO-214AC**





### DO-15 Reel Pack (RP) Specifications

Meets all EIA RS-296 Standards

